

300 Validated Non Interval Readings Scheduled

Meter Point Status
E - Energised
D - De-energised
Read Reason
01 Scheduled Read
10 Ad hoc, non chargeable check read
27 Change of Legal Entity
Read Type
A An actual reading obtained by ESB Networks
CU A reading provided directly by a customer
E An estimate due to a missing register reading / no access
ED An estimate due to a CoLE reading preceding the last DUoS billing date
EF An estimate due to an implausible reading / No read available
SC A customer reading provided by a Supplier
Read Status
RV Reading which is plausible / valid
RREL Reading was originally implausible but released on investigation as plausible
REST Reading was estimated and usage factors deriving from estimate will be used in Settlement. See Read Type for reason for estimate.
RENS Reading was estimate but usage factors are not updated and will not be used in settlement. This is generally because a full set of readings was estimated due to implausibility.
Optional/Mandatory; Although the following Data Items are optional, note the following caveats:-
Actual Usage Factor: Provided by the period terminating on the read date
Estimated Usage Factor: Provided for the period following the read date

Message

RMDS RETAIL MARKET DESIGN SERVICE

Message Specific information

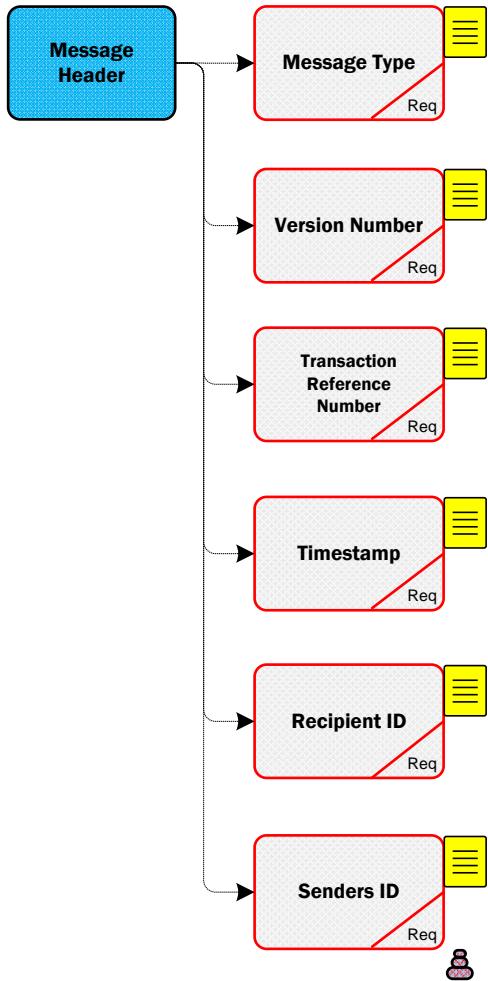

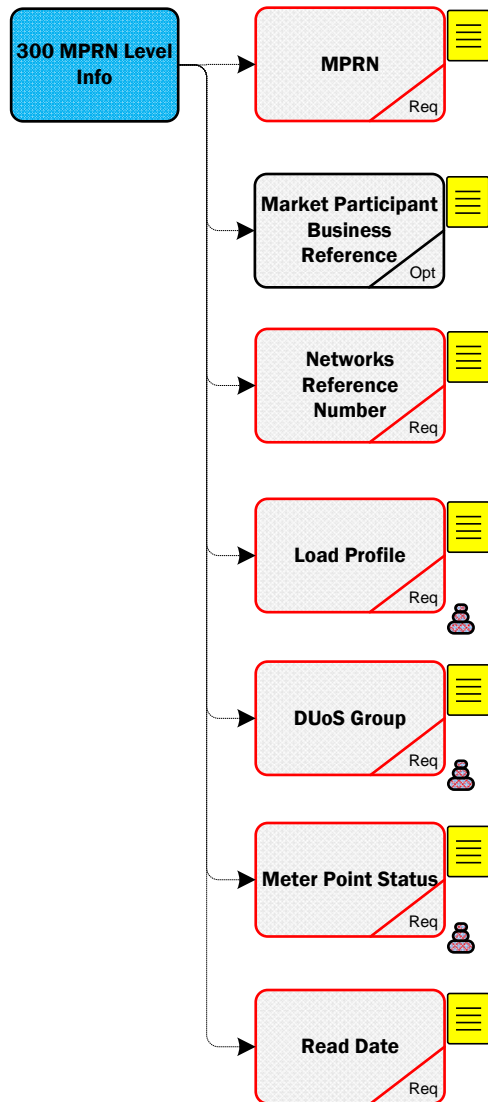

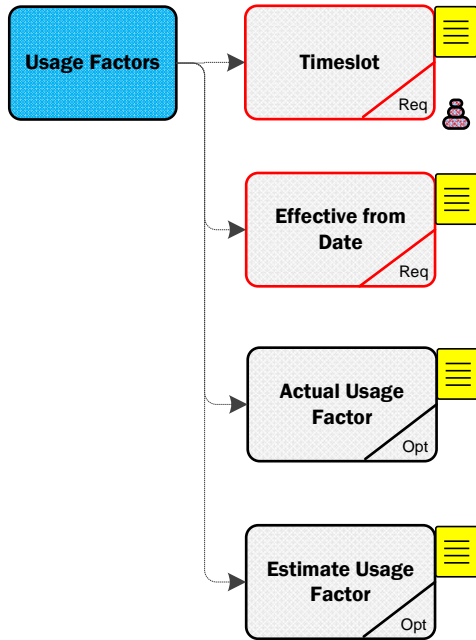

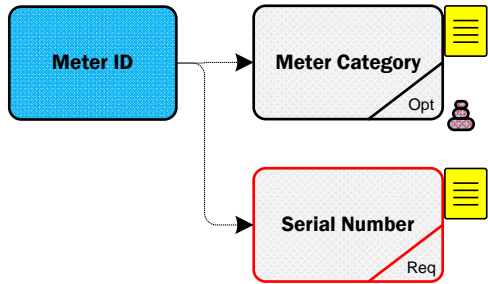

Register Level Information

Meter Registration Sequence
Req

Timeslot
Req

Unit of Measurement
Req

Meter Multiplier
Req

Reading
Req

Read Reason
Req

Read Type
Req

Register Type
Req

Previous Read Date
Req

Consumption
Opt

Read Status
Req

**Senders
ID**

**Click Here for Latest
Senders ID
List**

300 Validated Non Interval Readings Scheduled

Code

Load Profile

01 - Urban Domestic Unrestricted

10 - Unmetered - Flat

02 - Urban Domestic Day/Night

11 - Public Lighting Dusk/Dawn

03 - Rural Domestic Unrestricted

12 - Public Lighting Dusk/Midnight

04 - Rural Domestic Day/Night

05 - Non Domestic Unrestricted

06 - Non Domestic Day/Night

07 - MD with LF up to (but not including) 30%

08 - MD with LF greater than or equal to 30% but less than 50%

09 - MD with LF greater than or equal to 50%

Message

MPRN Level Information

RMDS RETAIL MARKET DESIGN SERVICE

Load Profile

300 Validated Non Interval Readings Scheduled

Code

DUoS Group

AGU	DG1	Urban Domestic	DG7	MV MD
AMM	DG10	Yes	DG7A	MV MD Autoproducer
CAN	DG2	Rural Domestic	DG7B	MV MD Importing Autoproducer or CHP Producer
CIP	DG3	Public Lighting	DG8	38 kV Looped MD
COL	DG4	Unmetered Supplies	DG8A	38 kV Looped MD Autoproducer
COS	DG5	LV Non-Domestic Non-MD	DG8B	38 kV Looped MD Importing Autoproducer or CHP Producer
CUG	DG5A	LV Non-Domestic Non-MD Autoproducer	DG9	38 kV Tailed MD
DIJ	DG5B	LV Non-Domestic Non-MD Importing Autoproducer or CHP Producer	DG9A	38 kV Tailed MD Autoproducer
DSO	DG6	LV MD	DG9B	38 kV Tailed MD Importing Autoproducer or CHP Producer
IA	DG6A	LV MD Autoproducer	DG10	110kV Distribution
ICD	DG6B	LV MD Importing Autoproducer or CHP Producer	TCON	Transmission Connected

Message

MPRN Level Information

RMDS RETAIL MARKET DESIGN SERVICE

DUoS Group

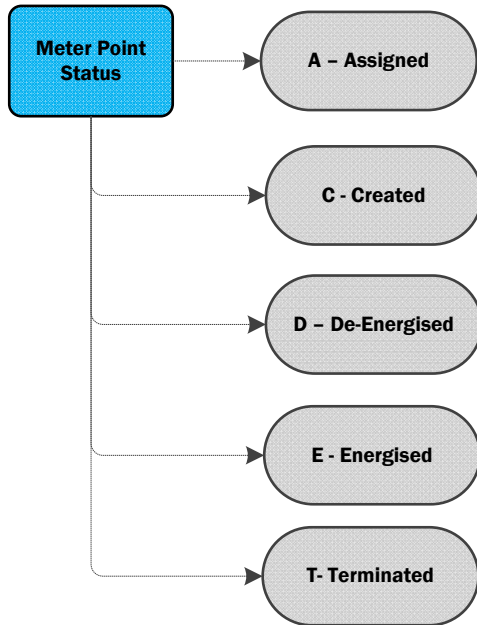

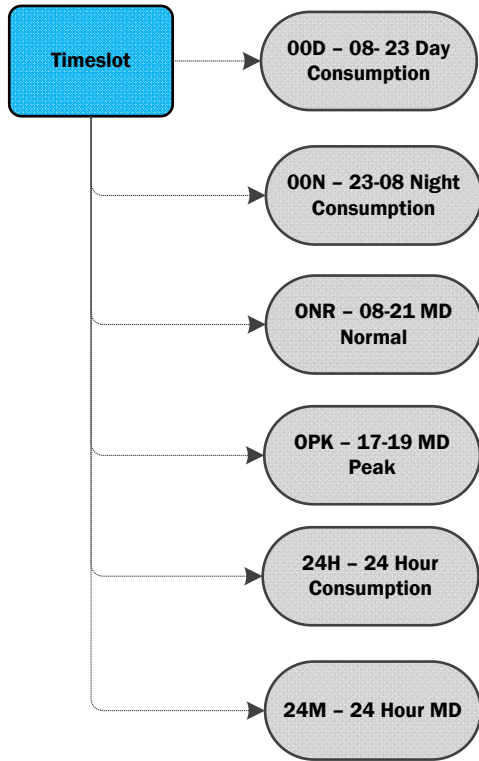

300 Validated Non Interval Readings Scheduled

Code

Meter Category

RM001	Single Tariff kWh	RM228	Double Tariff kWh	RM511	Single Tariff kWh	RM621	C.T. Double Tariff kWh	RM752	M.F.M.
RM002	Single Tariff kWh	RM229	Double Tariff kWh	RM512	Single Tariff kWh	RM622	C.T. Double Tariff kWh	RM753	Double Tariff Mechanical MD
RM003	Single Tariff kWh	RM230	Double Tariff kWh	RM513	Single Tariff kWh	RM623	C.T. Double Tariff kWh	RM754	M.F.M.
RM004	Single Tariff kWh	RM231	Double Tariff kWh	RM514	Single Tariff kWh	RM624	C.T. Double Tariff kWh	RM755	M.F.M.
RM005	Single Tariff kWh	RM232	Double Tariff kWh 2 Element	RM515	Single Tariff kWh	RM625	C.T. Double Tariff kWh	RM756	M.F.M.
RM006	Single Tariff kWh	RM233	Double Tariff kWh 2 Element	RM516	3-Phase Mechanical Single Tariff Meter	RM626	C.T. Double Tariff kWh	RM757	M.F.M.
RM007	Single Tariff kWh	RM234	Double Tariff kWh	RM520	Double Tariff kWh	RM627	Electronic Double Tariff kWh	RM758	M.F.M.
RM008	Single Tariff kWh	RM235	Double Tariff kWh	RM521	Double Tariff kWh	RM640	C.T. Single Tariff Mech anical MD	RM759	M.F.M.
RM010	Single Tariff kWh	RM250	Electronic Double Tariff kWh	RM522	Double Tariff kWh	RM641	C.T. Single Tariff Mech anical MD	RM760	M.F.M.
RM011	Single Tariff kWh	RM251	Double Tariff kWh 2 Element	RM523	Double Tariff kWh	RM645	M.F.M.	RM761	M.F.M.
RM020	Single Tariff kWh	RM252	Electronic Double Tariff kWh	RM524	Double Tariff kWh	RM646	M.F.M.	RM762	M.F.M.
RM021	Single Tariff kWh	RM253	Electronic Double Tariff kWh (AMPY 5224E)	RM525	Double Tariff kWh	RM647	M.F.M.	RM763	M.F.M.
RM022	Single Tariff kWh	RM255	Electronic Multi rate kWh	RM526	Double Tariff kWh	RM648	M.F.M.	RM764	M.F.M.
RM030	Single Tariff kWh	RM256	Electronic Multi rate kWh	RM527	Double Tariff kWh	RM649	M.F.M.	RM765	M.F.M.
RM031	Single Tariff kWh	RM257	Electronic Multi Rate kWh	RM528	Double Tariff kWh	RM650	M.F.M.	RM766	M.F.M.
RM032	Single Tariff kWh	RM258	Electronic Multi Rate kWh	RM529	Double Tariff kWh	RM651	M.F.M.	RM767	M.F.M.
RM033	Single Tariff kWh	RM259	Electronic Multi Rate kWh	RM530	Double Tariff kWh	RM652	M.F.M.	RM768	M.F.M.
RM034	Single Tariff kWh	RM280	Hardw ired	RM531	Double Tariff kWh	RM660	C.T. Double Tariff Mechanical MD	RM769	M.F.M.
RM035	Single Tariff kWh	RM281	DLC	RM532	Double Tariff kWh	RM661	C.T. Double Tariff Mechanical MD	RM770	Single Tariff kVArh
RM036	Single Tariff kWh	RM300	Smart GPRS 3Ph WC 1-20(100)	RM533	Double Tariff kWh	RM662	C.T. Double Tariff Mechanical MD	RM771	Single Tariff kVArh
RM039	Single Tariff kWh	RM301	Smart DLC 3PH WC 0.25-5(80)A	RM534	RM534 - Electronic Double Tariff kWh	RM663	C.T. Double Tariff Mechanical MD	RM772	Single Tariff kVArh
RM040	Single Tariff kWh	RM302	Smart RF 3PH WC 0.5-10(100)A	RM540	Mechanical MD	RM664	C.T. Double Tariff Mechanical MD	RM773	Single Tariff kVArh
RM041	Single Tariff kWh	RM303	Smart RF 3PH WC 1-20(100)A	RM541	Mechanical MD	RM665	C.T. Double Tariff Mechanical MD	RM774	Single Tariff kVArh
RM042	Single Tariff kWh	RM304	Smart PLC 3PH WC 1-20(100)A	RM542	Mechanical MD	RM666	C.T. Double Tariff Mechanical MD	RM775	Single Tariff kVArh
RM043	Single Tariff kWh	RM350	Smart GPRS 3Ph WC 1-20(100)	RM543	Mechanical MD	RM667	M.F.M.	RM776	Single Tariff kVArh
RM050	Electronic Single Tariff kWh	RM351	Smart DLC 3PH CT 0.25-5(80)A	RM545	M.F.M.	RM670	C.T. kVArh	RM777	Single Tariff kVArh
RM051	Single Tariff kWh Budget Controller	RM352	Smart RF 3PH CT 0.5-10(100)A	RM546	M.F.M.	RM671	C.T. kVArh	RM780	Summator
RM052	Single Tariff kWh Budget Controller	RM353	Smart RF 3PH CT 1-20(100)A	RM547	M.F.M.	RM672	C.T. kVArh	RM781	M.F.M. (PWRM/PML Ion 7600)
RM054	Single Tariff kWh Budget Controller	RM354	Smart PLC 3PH CT 1-20(100)A	RM548	M.F.M.	RM673	C.T. kVArh	RM782	M.F.M. (PWRM/PML Ion 7650)
RM055	Single Tariff kWh Budget Controller	RM400	Single Tariff Current Transformer kWh	RM549	M.F.M.	RM674	C.T. kVArh	RM783	M.F.M. (PWRM/PML Ion 7650)
RM056	Single Tariff kWh Budget Controller	RM401	Single Tariff Current Transformer kWh	RM550	M.F.M. (Elster A1140)	RM675	C.T. kVArh	RM784	Summator (PSI Siemens Maxsys V2737/R33)
RM066	Electronic Single Tariff kWh	RM402	Single Tariff Current Transformer kWh	RM551	M.F.M.	RM676	C.T. kVArh	RM785	M.F.M
RM067	Electronic Single Tariff kWh	RM403	Single Tariff Current Transformer kWh	RM552	M.F.M.	RM720	Double Tariff kWh	RMAB1	Single Phase Single Tariff kWh
RM068	Electronic Single Tariff kWh	RM420	Double Tariff Current Transformer kWh	RM553	M.F.M.	RM721	Double Tariff kWh	RMAB3	Single Tariff kWh
RM100	Smart GPRS 1PH WC 1-20(100)A	RM421	Double Tariff Current Transformer kWh	RM570	Single Tariff kVArh	RM722	Double Tariff kWh	RMB10	Single Phase Single Tariff kWh
RM101	Smart DLC 1PH WC 0.25-5(80)A	RM422	Double Tariff Current Transformer kWh	RM571	Single Tariff kVArh	RM723	Double Tariff kWh	RMB14	Single Phase Single Tariff kWh
RM102	Smart RF 1PH WC 0.5-10(100)A	RM423	Double Tariff Current Transformer kWh	RM572	Single Tariff kVArh	RM740	Single Tariff Mechanical MD	RMB15	Single Tariff kWh
RM103	Smart RF 1PH WC 1-20(100)A	RM424	Double Tariff Current Transformer kWh	RM573	Single Tariff kVArh	RM741	Single Tariff Mechanical MD	RMB16	Single Phase Single Tariff kWh
RM104	Smart RF 1PH WC 1-20(100)A	RM425	Double Tariff Current Transformer kWh	RM574	Single Tariff kVArh	RM742	Single Tariff Mechanical MD	RMB20	Single Phase Single Tariff kWh
RM105	Smart PLC 1PH WC 1-20(100)A	RM426	Double Tariff Current Transformer kWh	RM575	Single Tariff kVArh	RM743	Double Tariff Mechanical MD	RMB34	Single Tariff kWh
RM220	Double Tariff kWh	RM500	Single Tariff kWh	RM576	Single Tariff kVArh	RM744	Double Tariff Mechanical MD	RMB36	Single Tariff kWh
RM221	Double Tariff kWh	RM501	Single Tariff kWh	RM600	C.T. Single Tariff kWh	RM745	Double Tariff Mechanical MD	RMB40	Single Phase Single Tariff kWh
RM222	Double Tariff kWh	RM502	Single Tariff kWh	RM601	C.T. Single Tariff kWh	RM746	Double Tariff Mechanical MD	RMB45	Single Phase Single Tariff kWh
RM223	Double Tariff kWh	RM503	Single Tariff kWh	RM602	C.T. Single Tariff kWh	RM747	Double Tariff Mechanical MD	RMB60	Single Phase Single Tariff kWh
RM224	Double Tariff kWh	RM504	Single Tariff kWh	RM603	C.T. Single Tariff kWh	RM748	Double Tariff Mechanical MD	RMB63	Single Tariff kWh
RM225	Double Tariff kWh	RM505	Single Tariff kWh	RM604	C.T. Single Tariff kWh	RM749	Double Tariff Mechanical MD	RMB80	Single Phase Single Tariff kWh
RM226	Double Tariff kWh	RM506	Single Tariff kWh	RM617	C.T. kVArh	RM750	Double Tariff Mechanical MD	RMDT1	Double Tariff kWh
RM227	Double Tariff kWh	RM510	Single Tariff kWh	RM620	C.T. Double Tariff kWh	RM751	Double Tariff Mechanical MD	RMDT3	Double Tariff kWh
								TKMTR	Single Phase Single Tariff kWh

Message

Meter ID

RMDS RETAIL MARKET DESIGN SERVICE

Meter Category

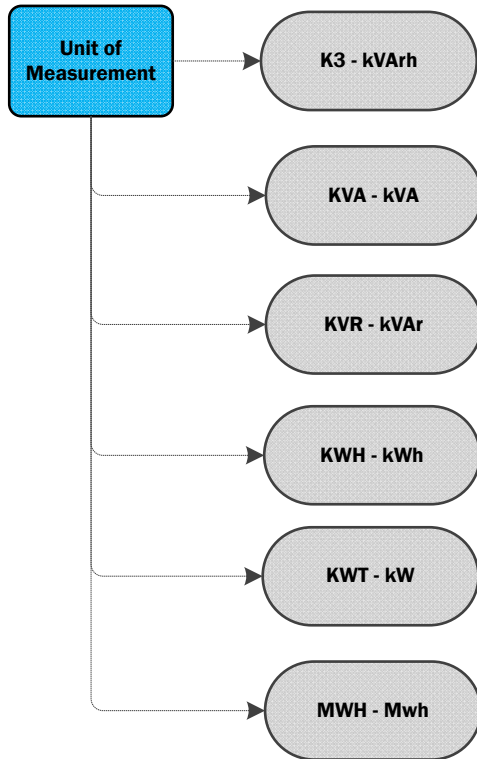

300 Validated Non Interval Readings Scheduled

Code

Read Reason

01 - Scheduled

17 - Change of Profile

95 - Not for CoS

02 - Special Read, Chargeable

18 - Energisation

04 - Special Read to resolve dispute

21 - Start Reading (New Register)

09 - Special Read, non chargeable

22 - Closing Reading (Register removed)

10 - Ad-hoc, no chargeable check read

23 - Meter Works Single reading

11 - Start reading after meter re-programming

26 - Change of Supplier

13 - De-Energisation

27 - Change of Legal Entity

14 - Estimate

28 - Closing read before register re-number

16 - Closing read before meter re-programming

29 - Star read after register re-number

Message

Register Level Info

RMDS RETAIL MARKET DESIGN SERVICE

Read Reason

300 Validated Non Interval Readings Scheduled

Code

Read Type

A - Actual

SU - Substitute
(Interval)

CU - Customer
Reading

E - Estimate (No
Access)

ED - Estimate (DUoS
Billing has occurred)

EF - Estimate
(Implausible/No
Read available)

EP - Estimate (Block
Planned)

EU - Estimate (Block
Unplanned)

RC - Replacement
Read

SC - Supplier
Provided Customer
Reading

Message

Register Level Info

RMDS RETAIL MARKET DESIGN SERVICE

Read Type

300 Validated Non Interval Readings Scheduled

Code

Register Type

01 - 24hr

50 - IMP QH (KW)

02 - Day

51 - IMP QH (kVAr)

03 - Night

52 - EXP QH(KW)

04 - NSH

53 - EXP QH (kVAr)

05 - Wattless

06 - MD Normal

07 - MD Peak

08 - Cumulative MD
Normal

09 - Cumulative MD
Peak

Message

Register Level Info

RMDS RETAIL MARKET DESIGN SERVICE

Register Type

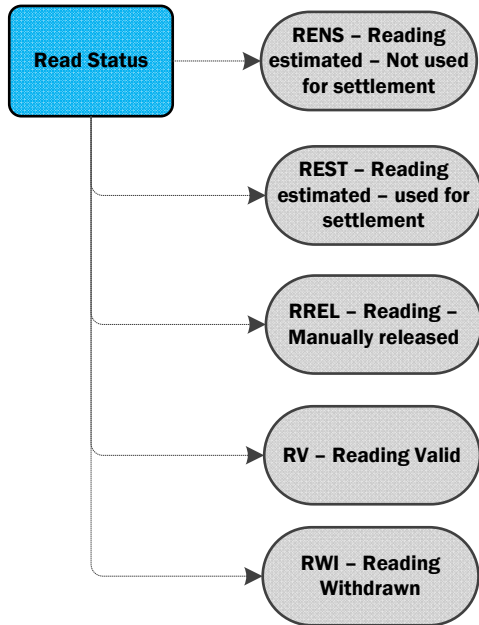

300 Validated Non Interval Readings Scheduled

Version Which Implemented	Source of Change	Description of Change
10.4	MCR 1155	Message format changed from ARIS to Document format.