

016 Change in Legal Entity

016 Valid Codes

Read Reason

This should always be set to code value **27** – Change of Legal Entity where provided.

Read Type

SC Supplier Provided Customer Reading

Required Date

Please Note: Where a future date is provided Networks will not process the Change of Legal Entity until the required date is reached.

- For NQH Metering less than 30Kva where a retrospective required date has been provided and if DUOS billing has occurred between current and required date, required date is ignored and the current date is used.
- For NQH Metering more than 30Kva and QH Metering the COLE is always carried out for the specified required date.
- For Maximum Demand metering COLE is date = to last Networks actual read.

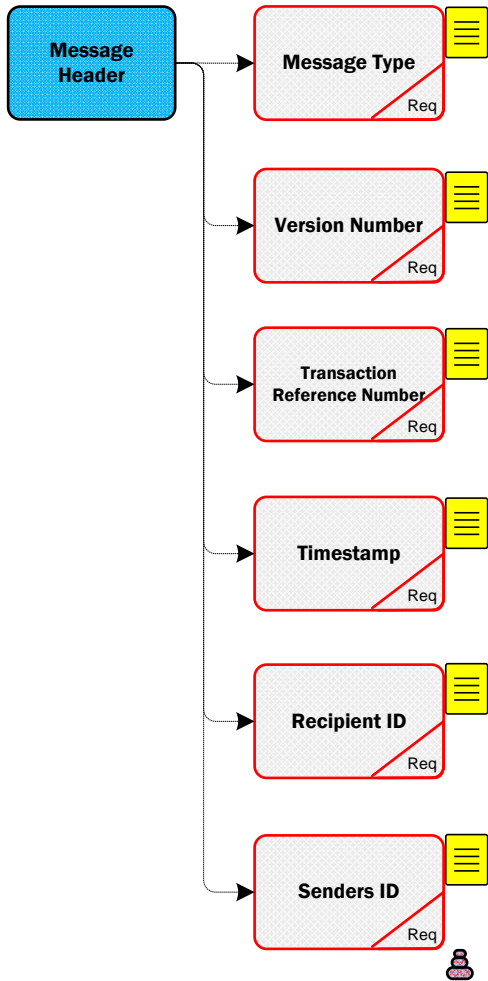

016 MPRN Level Info

MPRN
Req

Market Participant Business Reference
Req

Supply Agreement Flag
Req

Change of Usage
Opt

Economic Activity Indicator
Opt

Supplier ID
Req

Required Date
Opt

Read Reason
Opt

Display on Extranet
Opt

Medical Equipment Special Needs Details
Opt

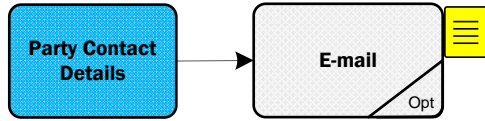

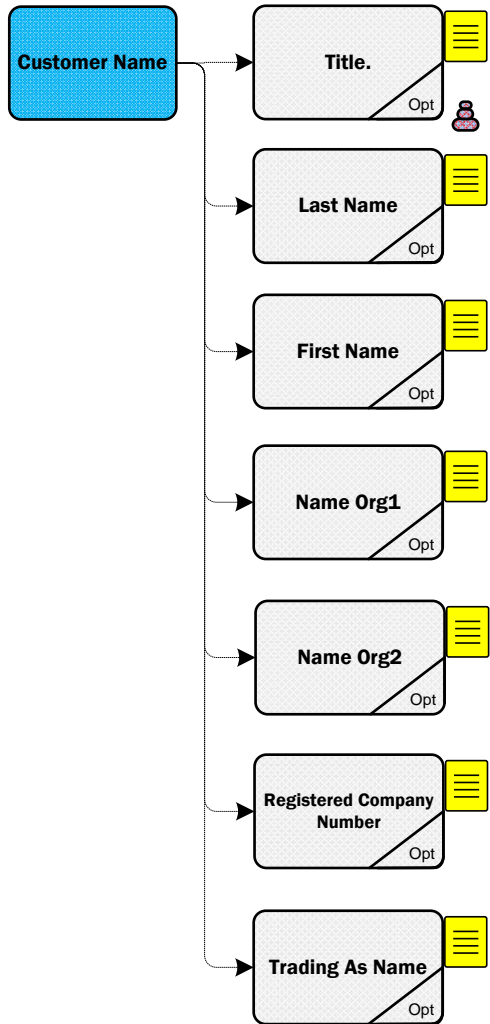

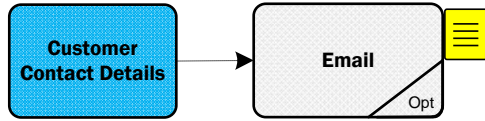

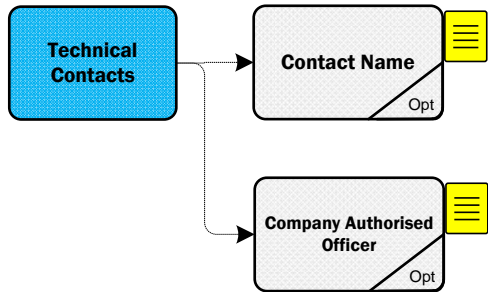

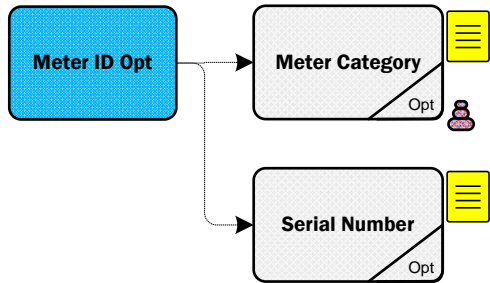

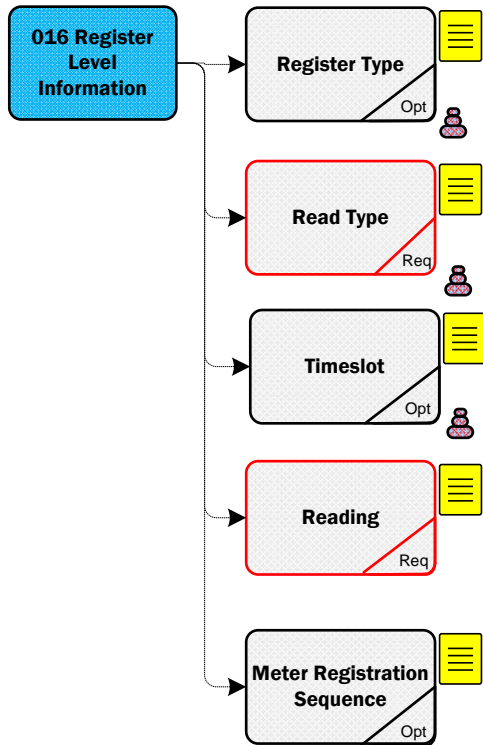

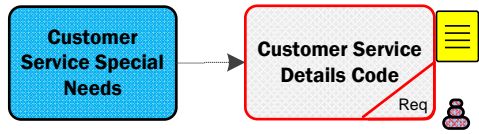

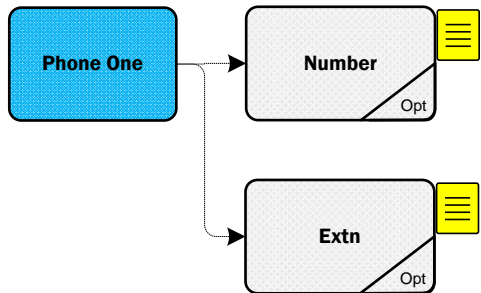

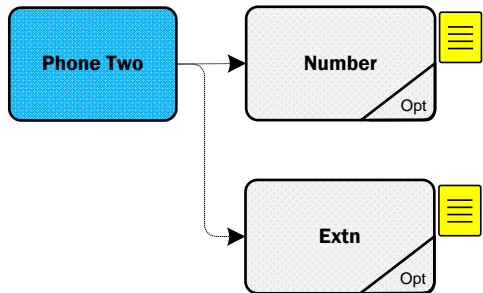

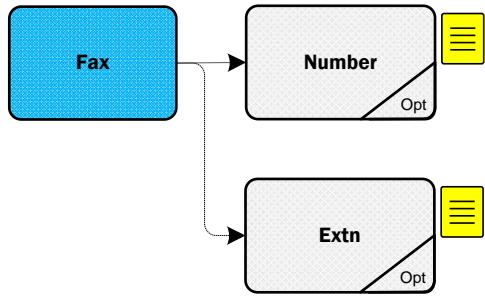

Address

C/O Name
Opt

Addr Line 5
Opt

Unit No.
Opt

Postal Code
Opt

Addr Line 1
Opt

City
Opt

Addr Line 2
Opt

County Ireland
Opt

House No.
Opt

County/State
Opt

Street
Req

Country
Opt

Addr Line 4
Opt

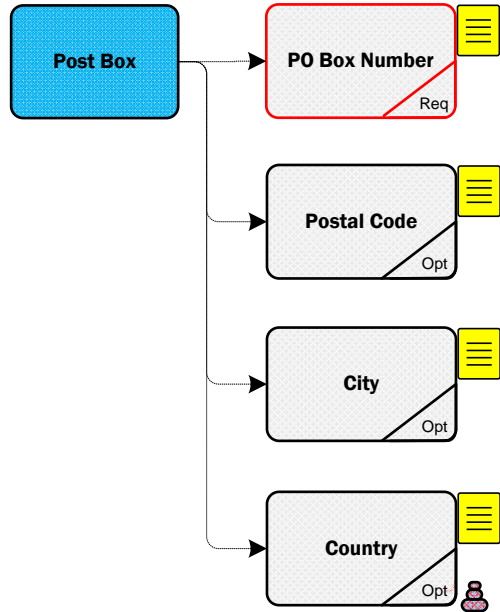

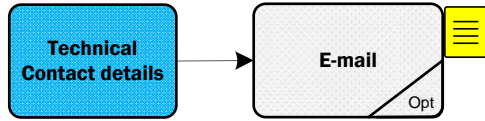

**Senders
ID**

**Click Here for Latest
Senders ID
List**

016 Change in Legal Entity

Code

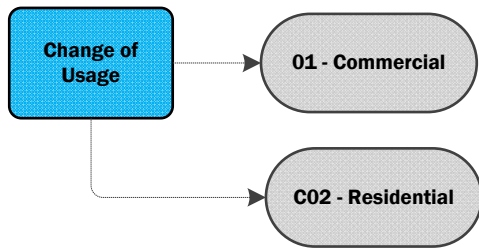

016 Change in Legal Entity

Code

Economic Activity Indicator

01	Agriculture, hunting and related service activities	28	Manufacture of fabricated metal products, except machinery and equipment	64	Post and telecommunications
02	Forestry, logging and related service activities	29	Manufacture of machinery and equipment n.e.c.	65	Financial intermediation, except insurance and pension funding
05	Fishing, fish farming and related service activities	30	Manufacture of office machinery and computers	66	Insurance and pension funding, except compulsory social security
10	Mining of coal and lignite; extraction of peat	31	Manufacture of electrical machinery and apparatus n.e.c.	67	Activities auxiliary to financial intermediation
11	Extraction of crude petroleum and natural gas; service activities incidental to oil and gas extraction, excluding surveying	32	Manufacture of radio, television and communication equipment and apparatus	70	Real estate activities
12	Mining of uranium and thorium ores	33	Manufacture of medical, precision and optical instruments, watches and clocks	71	Renting of machinery and equipment without operator and of personal and household goods
13	Mining of metal ores	34	Manufacture of motor vehicles, trailers and semi-trailers	72	Computer and related activities
14	Other mining and quarrying	35	Manufacture of other transport equipment	73	Research and development
15	Manufacture of food products and beverages	36	Manufacture of furniture; manufacturing n.e.c.	74	Other business activities
16	Manufacture of tobacco products	37	Recycling	75	Public administration and defence; compulsory social security
17	Manufacture of textiles	40	Electricity, gas, steam and hot water supply	80	Education
18	Manufacture of wearing apparel; dressing and dyeing of fur	41	Collection, purification and distribution of water	85	Health and social work
19	Tanning and dressing of leather; manufacture of luggage, handbags, saddlery, harness and footwear	45	Construction	90	Sewage and refuse disposal, sanitation and similar activities
20	Manufacture of wood and of products of wood and cork, except furniture; manufacture of articles of straw and plaiting materials	50	Sale, maintenance and repair of motor vehicles and motorcycles; retail sale of automotive fuel	91	Activities of membership organizations n.e.c.
21	Manufacture of pulp, paper and paper products	51	Wholesale trade and commission trade, except of motor vehicles and motorcycles	92	Recreational, cultural and sporting activities
22	Publishing, printing and reproduction of recorded media	52	Retail trade, except of motor vehicles and motorcycles; repair of personal and household goods	93	Other service activities
23	Manufacture of coke, refined petroleum products and nuclear fuel	55	Hotels and restaurants	95	Activities of households as employers of domestic staff
24	Manufacture of chemicals and chemical products	60	Land transport; transport via pipelines	96	Undifferentiated goods producing activities of private households for own use
25	Manufacture of rubber and plastic products	61	Water transport	97	Undifferentiated services producing activities of private households for own use
26	Manufacture of other non-metallic mineral products	62	Air transport	98	Domestic
27	Manufacture of basic metals	63	Supporting and auxiliary transport activities; activities of travel agencies	99	Extra-territorial organizations and bodies

Message

MPRN Level Info

RMDS RETAIL MARKET DESIGN SERVICE

Economic Activity Indicator

**Supplier
ID**

**Click Here for Latest
Supplier ID
List**

016 Change in Legal Entity

Code

Read Reason

01 - Scheduled

17 - Change of Profile

95 - Not for CoS

02 - Special Read, Chargeable

18 - Energisation

04 - Special Read to resolve dispute

21 - Start Reading (New Register)

09 - Special Read, non chargeable

22 - Closing Reading (Register removed)

10 - Ad-hoc, no chargeable check read

23 - Meter Works Single reading

11 - Start reading after meter re-programming

26 - Change of Supplier

13 - De-Energisation

27 - Change of Legal Entity

14 - Estimate

28 - Closing read before register re-number

16 - Closing read before meter re-programming

29 - Star read after register re-number

Message

MPRN Level Info

RMDS RETAIL MARKET DESIGN SERVICE

Read Reason

016 Change in Legal Entity

Code

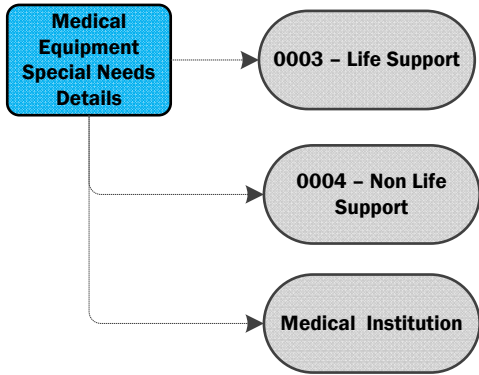

Title

Br - Brother

Msgr - Monsignor

Cltr - Councillor

Ms - Ms

Dr - Doctor

Prof - Professor

Fr - Father

Rec - Reverend

Lady - Lady

Sir - Sir

Lord - Lord

Sr - Sister

Miss - Miss

Mr - Mr

Mrs - Mrs

016 Change in Legal Entity

Code

County
Ireland

AM	Armagh	LK	Limerick	ZA	BHAILE ATHA CLIATHA	ZN	LIATROMA
AT	Antrim	LM	Leitrim	ZB	AN CHABHAIN	ZO	LOCH GARMAN
CE	Clare	LS	Laois	ZC	CHEATHARLACH	ZP	AN LONGFOIRT
CK	Cork	LY	Londonderry	ZD	CHIARRAI	ZQ	LU
CN	Cavan	MH	Meath	ZE	CHILL CHAINNIGH	ZR	LUIMNIGH
CW	Carlow	MN	Monaghan	ZF	CHILL DARA	ZS	MHAIGH EO
DB	Dublin	MO	Mayo	ZG	CHILL MHANTAIN	ZT	NA MI
DE	Derry	OY	Offaly	ZH	AN CHLAIR	ZU	MHUINEACHAIN
DL	Donegal	RN	Roscommon	ZI	CHORCAI	ZV	PHORT LAIRGE
DN	Dow n	SO	Sligo	ZJ	DHUN NA NGALL	ZW	ROS COMAIN
FM	Fermanagh	TP	Tipperary	ZK	NA GAILLIMHE	ZX	SHLIGIGH
GW	Galw ay	TY	Tyrone	ZL	NA HIARMHI	ZY	THIOBRAID ARANN
KE	Kildare	WD	Waterford	ZM	LAOISE	ZZ	UIBH FHAILI
KK	Kilkenny	WH	Westmeath				
KY	Kerry	WW	Wicklow				
LD	Longford	WX	Wexford				
LH	Louth						

Message

Address

RMDS RETAIL MARKET DESIGN SERVICE

County Ireland

016 Change in Legal Entity

Code

Country

AD	Andorra	CA	Canada	FO	Faroe Islands	JM	Jamaica	MP	N.Mariana Islnd	PW	Palau	TO	Tonga
AE	UAE	CC	Coconut Islands	FR	France	JO	Jordan	MQ	Martinique	PY	Paraguay	TP	East Timor
AF	Afghanistan	CD	Congo	GA	Gabon	JP	Japan	MR	Mauretania	QA	Qatar	TR	Turkey
AG	Antigua/Barbuda	CF	Central Afr.Rep	GB	United Kingdom	KE	Kenya	MS	Montserrat	RE	Reunion	TT	Trinidad,Tobago
AI	Anguilla	CG	Congo	GD	Grenada	KG	Kyrgyzstan	MT	Malta	RO	Romania	TV	Tuvalu
AL	Albania	CH	Switzerland	GE	Georgia	KH	Cambodia	MU	Mauritius	RU	Russian Fed.	TW	Taiwan
AM	Armenia	CI	Ivory Coast	GF	French Guayana	KI	Kiribati	MV	Maldives	RW	Rwanda	TZ	Tanzania
AN	Dutch Antilles	CK	Cook Islands	GH	Ghana	KM	Comoros	MW	Malawi	SA	Saudi Arabia	UA	Ukraine
AO	Angola	CL	Chile	GI	Gibraltar	KN	St Kitts&Nevis	MX	Mexico	SB	Solomon Islands	UG	Uganda
AQ	Antarctica	CM	Cameroon	GL	Greenland	KP	North Korea	MY	Malaysia	SC	Seychelles	UM	Minor Outl.Isl.
AR	Argentina	CN	China	GM	Gambia	KR	South Korea	MZ	Mozambique	SD	Sudan	US	USA
AS	Samoa, American	CO	Colombia	GN	Guinea	KW	Kuwait	NA	Namibia	SE	Sweden	UY	Uruguay
AT	Austria	CR	Costa Rica	GP	Guadeloupe	KY	Cayman Islands	NC	New Caledonia	SG	Singapore	UZ	Uzbekistan
AU	Australia	CU	Cuba	GQ	Equatorial Gui.	KZ	Kazakhstan	NE	Niger	SH	St. Helena	VA	Vatican City
AW	Aruba	CV	Cape Verde	GR	Greece	LA	Laos	NF	Norfolk Island	SI	Slovenia	VC	St. Vincent
AZ	Azerbaijan	CX	Christmas Islnd	GS	Sth Sandwich Is	LB	Lebanon	NG	Nigeria	SJ	Svalbard	VE	Venezuela
BA	Bosnia-Herz.	CY	Cyprus	GT	Guatemala	LC	St. Lucia	NI	Nicaragua	SK	Slovakia	VG	Brit.Virgin Is.
BB	Barbados	CZ	Czech Republic	GU	Guam	LI	Liechtenstein	NL	Netherlands	SL	Sierra Leone	VI	Amer.Virgin Is.
BD	Bangladesh	DE	Germany	GW	Guinea-Bissau	LK	Sri Lanka	NO	Norway	SM	San Marino	VN	Vietnam
BE	Belgium	DJ	Djibouti	GY	Guyana	LR	Liberia	NP	Nepal	SN	Senegal	VU	Vanuatu
BF	Burkina-Faso	DK	Denmark	HK	Hong Kong	LS	Lesotho	NR	Nauru	SO	Somalia	WF	Wallis, Futuna
BG	Bulgaria	DM	Dominica	HM	Heard/McDon.Isl	LT	Lithuania	NU	Niue Islands	SR	Suriname	WS	Western Samoa
BH	Bahrain	DO	Dominican Rep.	HN	Honduras	LU	Luxembourg	NZ	New Zealand	ST	S.Tome,Principe	YE	Yemen
BI	Burundi	DZ	Algeria	HR	Croatia	LV	Latvia	OM	Oman	SV	El Salvador	YT	Mayotte
BJ	Benin	EC	Ecuador	HT	Haiti	LY	Libya	PA	Panama	SY	Syria	YU	Yugoslavia
BM	Bermuda	EE	Estonia	HU	Hungary	MA	Morocco	PE	Peru	SZ	Swaziland	ZA	South Africa
BN	Brunei	EG	Egypt	ID	Indonesia	MC	Monaco	PF	Frenc.Polynesia	TC	Turksh Caicosin	ZM	Zambia
BO	Bolivia	EH	West Sahara	IE	Ireland	MD	Moldavia	PG	Pap. New Guinea	TD	Chad	ZW	Zimbabwe
BR	Brazil	ER	Eritrea	IL	Israel	MG	Madagascar	PH	Philippines	TF	French S.Territ		
BS	Bahamas	ES	Spain	IN	India	MH	Marshall Islnds	PK	Pakistan	TG	Togo		
BT	Bhutan	ET	Ethiopia	IO	Brit.Ind.Oc.Ter	MK	Macedonia	PL	Poland	TH	Thailand		
BV	Bouvet Island	FI	Finland	IQ	Iraq	ML	Mali	PM	St.Pier,Miquel.	TJ	Tajikstan		
BW	Botswana	FJ	Fiji	IR	Iran	MM	Myanmar	PN	Pitcairn Islnds	TK	Tokelau Islands		
BY	Belarus	FK	Falkland Islnds	IS	Iceland	MN	Mongolia	PR	Puerto Rico	TM	Turkmenistan		
BZ	Belize	FM	Micronesia	IT	Italy	MO	Macau	PT	Portugal	TN	Tunisia		

Message

Address

Post Box

RMDS RETAIL MARKET DESIGN SERVICE

Country

016 Change in Legal Entity

Code

Meter Category

RM001	Single Tariff kWh	RM228	Double Tariff kWh	RM511	Single Tariff kWh	RM621	C.T. Double Tariff kWh	RM752	M.F.M.
RM002	Single Tariff kWh	RM229	Double Tariff kWh	RM512	Single Tariff kWh	RM622	C.T. Double Tariff kWh	RM753	Double Tariff Mechanical MD
RM003	Single Tariff kWh	RM230	Double Tariff kWh	RM513	Single Tariff kWh	RM623	C.T. Double Tariff kWh	RM754	M.F.M.
RM004	Single Tariff kWh	RM231	Double Tariff kWh	RM514	Single Tariff kWh	RM624	C.T. Double Tariff kWh	RM755	M.F.M.
RM005	Single Tariff kWh	RM232	Double Tariff kWh 2 Element	RM515	Single Tariff kWh	RM625	C.T. Double Tariff kWh	RM756	M.F.M.
RM006	Single Tariff kWh	RM233	Double Tariff kWh 2 Element	RM516	3-Phase Mechanical Single Tariff Meter	RM626	C.T. Double Tariff kWh	RM757	M.F.M.
RM007	Single Tariff kWh	RM234	Double Tariff kWh	RM520	Double Tariff kWh	RM627	Electronic Double Tariff kWh	RM758	M.F.M.
RM008	Single Tariff kWh	RM235	Double Tariff kWh	RM521	Double Tariff kWh	RM640	C.T. Single Tariff Mech anical MD	RM759	M.F.M.
RM010	Single Tariff kWh	RM250	Electronic Double Tariff kWh	RM522	Double Tariff kWh	RM641	C.T. Single Tariff Mech anical MD	RM760	M.F.M.
RM011	Single Tariff kWh	RM251	Double Tariff kWh 2 Element	RM523	Double Tariff kWh	RM645	M.F.M.	RM761	M.F.M.
RM020	Single Tariff kWh	RM252	Electronic Double Tariff kWh	RM524	Double Tariff kWh	RM646	M.F.M.	RM762	M.F.M.
RM021	Single Tariff kWh	RM253	Electronic Double Tariff kWh (AMPY 5224E)	RM525	Double Tariff kWh	RM647	M.F.M.	RM763	M.F.M.
RM022	Single Tariff kWh	RM255	Electronic Multi rate kWh	RM526	Double Tariff kWh	RM648	M.F.M.	RM764	M.F.M.
RM030	Single Tariff kWh	RM256	Electronic Multi rate kWh	RM527	Double Tariff kWh	RM649	M.F.M.	RM765	M.F.M.
RM031	Single Tariff kWh	RM257	Electronic Multi Rate kWh	RM528	Double Tariff kWh	RM650	M.F.M.	RM766	M.F.M.
RM032	Single Tariff kWh	RM259	Electronic Multi Rate kWh	RM529	Double Tariff kWh	RM651	M.F.M.	RM767	M.F.M.
RM033	Single Tariff kWh	RM259	Electronic Multi Rate kWh	RM530	Double Tariff kWh	RM652	M.F.M.	RM768	M.F.M.
RM034	Single Tariff kWh	RM280	Hardwired	RM531	Double Tariff kWh	RM660	C.T. Double Tariff Mechanical MD	RM769	M.F.M.
RM035	Single Tariff kWh	RM281	DLC	RM532	Double Tariff kWh	RM661	C.T. Double Tariff Mechanical MD	RM770	Single Tariff kVArh
RM036	Single Tariff kWh	RM300	Smart GPRS 3Ph WC 1-20(100)	RM533	Double Tariff kWh	RM771	C.T. Double Tariff Mechanical MD	RM771	Single Tariff kVArh
RM039	Single Tariff kWh	RM301	Smart DLC 3PH WC 0.25-5(80)A	RM534	RM534 - Electronic Double Tariff kWh	RM663	C.T. Double Tariff Mechanical MD	RM772	Single Tariff kVArh
RM040	Single Tariff kWh	RM302	Smart RF 3PH WC 0.5-10(100)A	RM540	Mechanical MD	RM664	C.T. Double Tariff Mechanical MD	RM773	Single Tariff kVArh
RM041	Single Tariff kWh	RM303	Smart RF 3PH WC 1-20(100)A	RM541	Mechanical MD	RM665	C.T. Double Tariff Mechanical MD	RM774	Single Tariff kVArh
RM042	Single Tariff kWh	RM304	Smart PLC 3PH WC 1-20(100)A	RM542	Mechanical MD	RM666	C.T. Double Tariff Mechanical MD	RM775	Single Tariff kVArh
RM043	Single Tariff kWh	RM350	Smart GPRS 3Ph WC 1-20(100)	RM543	Mechanical MD	RM667	M.F.M.	RM776	Single Tariff kVArh
RM050	Electronic Single Tariff kWh	RM351	Smart DLC 3PH CT 0.25-5(80)A	RM545	M.F.M.	RM670	C.T. kVArh	RM777	Single Tariff kVArh
RM051	Single Tariff kWh Budget Controller	RM352	Smart RF 3PH CT 0.5-10(100)A	RM546	M.F.M.	RM671	C.T. kVArh	RM780	Summator
RM052	Single Tariff kWh Budget Controller	RM353	Smart RF 3PH CT 1-20(100)A	RM547	M.F.M.	RM672	C.T. kVArh	RM781	M.F.M. (PWRM/PML Ion 7600)
RM054	Single Tariff kWh Budget Controller	RM354	Smart PLC 3PH CT 1-20(100)A	RM548	M.F.M.	RM673	C.T. kVArh	RM782	M.F.M. (PWRM/PML Ion 7650)
RM055	Single Tariff kWh Budget Controller	RM400	Single Tariff Current Transformer kWh	RM549	M.F.M.	RM674	C.T. kVArh	RM783	M.F.M. (PWRM/PML Ion 7650)
RM056	Single Tariff kWh Budget Controller	RM401	Single Tariff Current Transformer kWh	RM550	M.F.M. (Elster A1140)	RM675	C.T. kVArh	RM784	Summator (PSI Siemens Maxsys V2737/R33)
RM066	Electronic Single Tariff kWh	RM402	Single Tariff Current Transformer kWh	RM551	M.F.M.	RM676	C.T. kVArh	RM785	M.F.M
RM067	Electronic Single Tariff kWh	RM403	Single Tariff Current Transformer kWh	RM552	M.F.M.	RM720	Double Tariff kWh	RMAB1	Single Phase Single Tariff kWh
RM068	Electronic Single Tariff kWh	RM420	Double Tariff Current Transformer kWh	RM553	M.F.M.	RM721	Double Tariff kWh	RMAB3	Single Tariff kWh
RM100	Smart GPRS 1PH WC 1-20(100)A	RM421	Double Tariff Current Transformer kWh	RM570	Single Tariff kVArh	RM722	Double Tariff kWh	RMB10	Single Phase Single Tariff kWh
RM101	Smart DLC 1PH WC 0.25-5(80)A	RM422	Double Tariff Current Transformer kWh	RM571	Single Tariff kVArh	RM723	Double Tariff kWh	RMB14	Single Phase Single Tariff kWh
RM102	Smart RF 1PH WC 0.5-10(100)A	RM423	Double Tariff Current Transformer kWh	RM572	Single Tariff kVArh	RM740	Single Tariff Mechanical MD	RMB15	Single Tariff kWh
RM103	Smart RF 1PH WC 1-20(100)A	RM424	Double Tariff Current Transformer kWh	RM573	Single Tariff kVArh	RM741	Single Tariff Mechanical MD	RMB16	Single Phase Single Tariff kWh
RM104	Smart RF 1PH WC 1-20(100)A	RM425	Double Tariff Current Transformer kWh	RM574	Single Tariff kVArh	RM742	Single Tariff Mechanical MD	RMB20	Single Phase Single Tariff kWh
RM105	Smart PLC 1PH WC 1-20(100)A	RM426	Double Tariff Current Transformer kWh	RM575	Single Tariff kVArh	RM743	Double Tariff Mechanical MD	RMB34	Single Tariff kWh
RM220	Double Tariff kWh	RM500	Single Tariff kWh	RM576	Single Tariff kVArh	RM744	Double Tariff Mechanical MD	RMB36	Single Tariff kWh
RM221	Double Tariff kWh	RM501	Single Tariff kWh	RM600	C.T. Single Tariff kWh	RM745	Double Tariff Mechanical MD	RMB40	Single Phase Single Tariff kWh
RM222	Double Tariff kWh	RM502	Single Tariff kWh	RM601	C.T. Single Tariff kWh	RM746	Double Tariff Mechanical MD	RMB45	Single Phase Single Tariff kWh
RM223	Double Tariff kWh	RM503	Single Tariff kWh	RM602	C.T. Single Tariff kWh	RM747	Double Tariff Mechanical MD	RMB60	Single Phase Single Tariff kWh
RM224	Double Tariff kWh	RM504	Single Tariff kWh	RM603	C.T. Single Tariff kWh	RM748	Double Tariff Mechanical MD	RMB63	Single Tariff kWh
RM225	Double Tariff kWh	RM505	Single Tariff kWh	RM604	C.T. Single Tariff kWh	RM749	Double Tariff Mechanical MD	RMB80	Single Phase Single Tariff kWh
RM226	Double Tariff kWh	RM506	Single Tariff kWh	RM617	C.T. kVArh	RM750	Double Tariff Mechanical MD	RMDT1	Double Tariff kWh
RM227	Double Tariff kWh	RM510	Single Tariff kWh	RM620	C.T. Double Tariff kWh	RM751	Double Tariff Mechanical MD	RMDT3	Double Tariff kWh
								TKMTR	Single Phase Single Tariff kWh

Message

Meter ID Opt

RMDS RETAIL MARKET DESIGN SERVICE

Meter Category

016 Change in Legal Entity

Code

Register Type

01 - 24hr

50 - IMP QH (KW)

02 - Day

51 - IMP QH (kVAr)

03 - Night

52 - EXP QH(KW)

04 - NSH

53 - EXP QH (kVAr)

05 - Wattless

06 - MD Normal

07 - MD Peak

08 - Cumulative MD Normal

09 - Cumulative MD Peak

Message

106 Register Level Info

Register Type

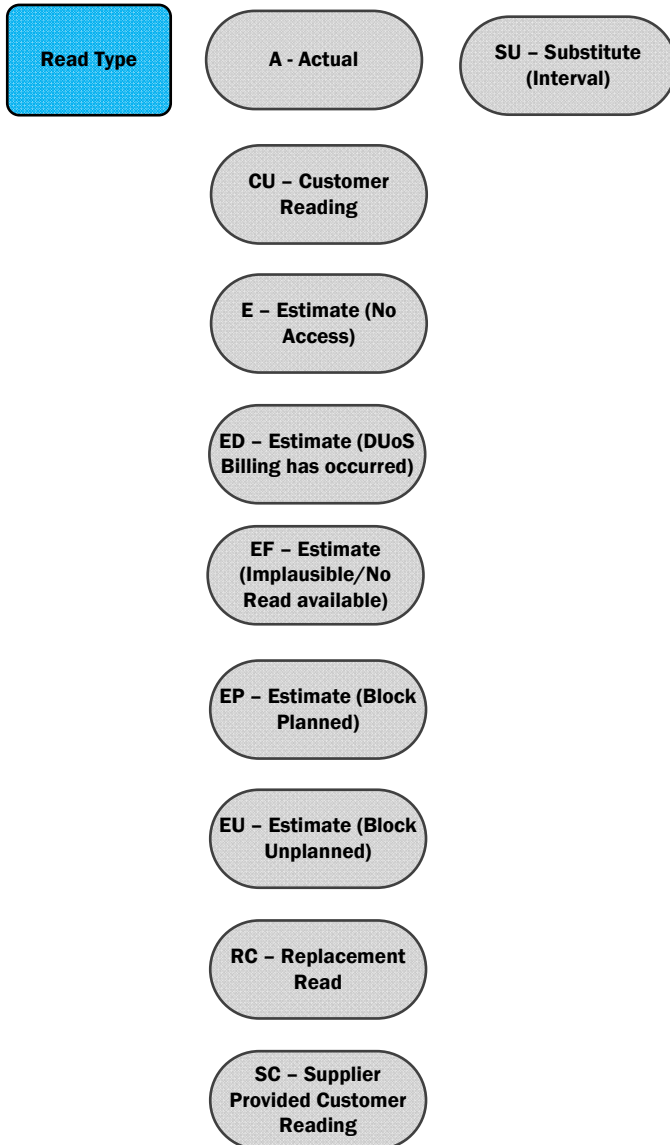

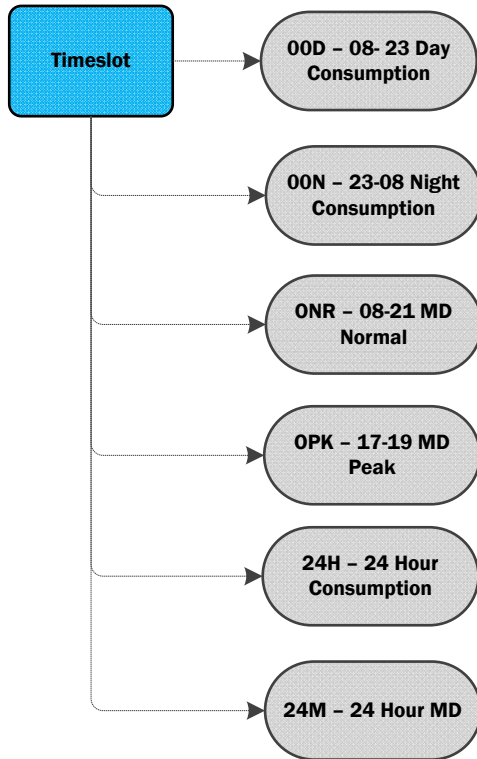

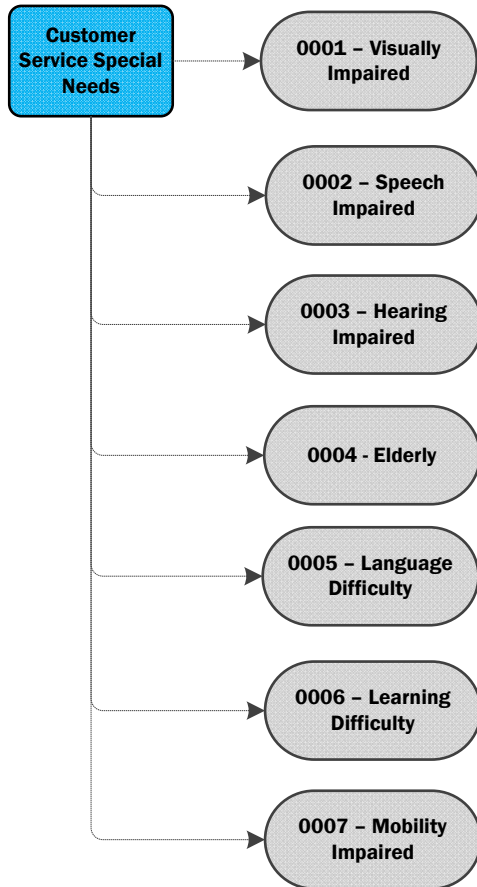

016 Change in Legal Entity

Version Which Implemented	Source of Change	Description of Change
10.4	MCR 1155	Message format changed from ARIS to Document format.